

User Manual

Version 1.0 June 2013

VT15 Hardware System

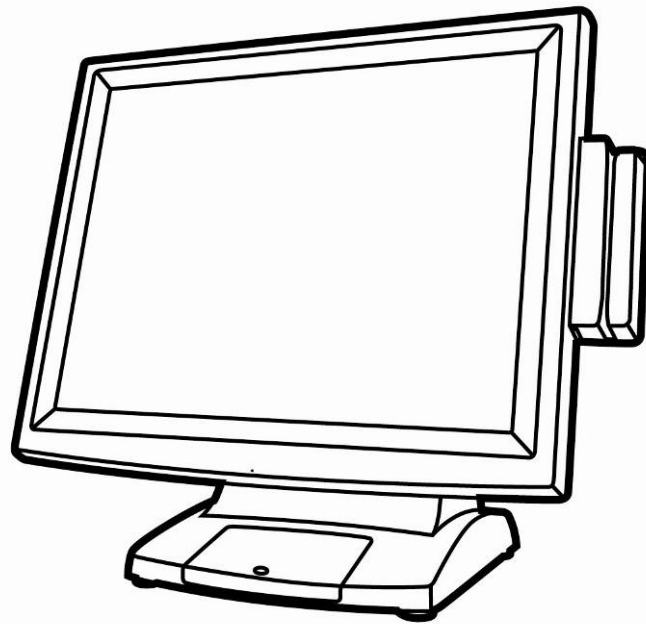

The information contained in this document is subject to change without notice.

We make no warranty of any kind with regard to this material, including, but not limited to, the implied warranties of merchantability and fitness for a particular purpose. We shall not be liable for errors contained herein or for incidental or consequential damages in connection with the furnishing, performance, or use of this material.

This document contains proprietary information that is protected by copyright. All rights are reserved. No part of this document may be photocopied, reproduced or translated to another language without the prior written consent of the manufacturer.

TRADEMARK

Intel®, Pentium® and MMX are registered trademarks of Intel® Corporation. Microsoft® and Windows® are registered trademarks of Microsoft Corporation.

Other trademarks mentioned herein are the property of their respective owners.

Safety

IMPORTANT SAFETY INSTRUCTIONS

1. To disconnect the machine from the electrical Power Supply, turn off the power switch and remove the power cord plug from the wall socket. The wall socket must be easily accessible and in close proximity to the machine.
2. Read these instructions carefully. Save these instructions for future reference.
3. Follow all warnings and instructions marked on the product.
4. Do not use this product near water.
5. Do not place this product on an unstable cart, stand, or table. The product may fall, causing serious damage to the product.
6. Slots and openings in the cabinet and the back or bottom are provided for ventilation; to ensure reliable operation of the product and to protect it from overheating. These openings must not be blocked or covered. The openings should never be blocked by placing the product on a bed, sofa, rug, or other similar surface. This product should never be placed near or over a radiator or heat register, or in a built-in installation unless proper ventilation is provided.
7. This product should be operated from the type of power indicated on the marking label. If you are not sure of the type of power available, consult your dealer or local power company.
8. Do not allow anything to rest on the power cord. Do not locate this product where persons will walk on the cord.
9. Never push objects of any kind into this product through cabinet slots as they may touch dangerous voltage points or short out parts that could result in a fire or electric shock. Never spill liquid of any kind on the product.

CE MARK



This device complies with the requirements of the EEC directive 2004/108/EC with regard to “Electromagnetic compatibility” and 2006/95/EC “Low Voltage Directive”

FCC

This device complies with part 15 of the FCC rules. Operation is subject to the following two conditions:

- (1) This device may not cause harmful interference.
- (2) This device must accept any interference received, including interference that may cause undesired operation

CAUTION ON LITHIUM BATTERIES

There is a danger of explosion if the battery is replaced incorrectly. Replace only with the same or equivalent type recommended by the manufacturer. Discard used batteries according to the manufacturer's instructions.



Battery Caution

Risk of explosion if battery is replaced by an incorrectly type.
Dispose of used battery according to the local disposal instructions.



Safety Caution

Note: To comply with IEC60950-1 Clause 2.5 (limited power sources, L.P.S) related legislation, peripherals shall be 4.7.3.2 "Materials for fire enclosure" compliant.

4.7.3.2 Materials for fire enclosures

For MOVABLE EQUIPMENT having a total mass not exceeding 18kg.the material of a FIRE ENCLOSURE, in the thinnest significant wall thickness used, shall be of V-1 CLASS MATERIAL or shall pass the test of Clause A.2.

For MOVABLE EQUIPMENT having a total mass exceeding 18kg and for all STATIONARY EQUIPMENT, the material of a FIRE ENCLOSURE, in the thinnest significant wall thickness used, shall be of 5VB CLASS MATERIAL or shall pass the test of Clause A.1

LEGISLATION AND WEEE SYMBOL

2012/19/EU Waste Electrical and Electronic Equipment Directive on the treatment, collection, recycling and disposal of electric and electronic devices and their components.



The crossed dustbin symbol on the device means that it should not be disposed of with other household wastes at the end of its working life. Instead, the device should be taken to the waste collection centers for activation of the treatment, collection, recycling and disposal procedure.

To prevent possible harm to the environment or human health from uncontrolled waste disposal, please separate this from other types of wastes and recycle it responsibly to promote the sustainable reuse of material resources.

Household users should contact either the retailer where they purchased this product, or their local government office, for details of where and how they can take this item for environmentally safe recycling.

Business users should contact their supplier and check the terms and conditions of the purchase contract.

This product should not be mixed with other commercial wastes for disposal.

Revision History



Revision	Date	Description
V1.0	June, 2013	● Release

Table of Contents

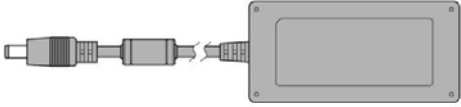
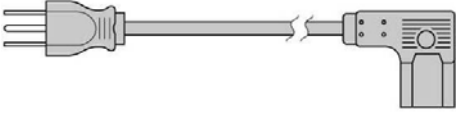

1 Item Checklist.....	1
1-1 Standard Items.....	1
1-2 Optional Items	2
2 System View	3
2-1 Front View	3
2-2 Rear View	4
2-3 Bottom View.....	5
2-4 I/O View.....	6
3 Peripherals Installation.....	7
3-1 MSR Installation	7
3-2 VFD Installation	8
3-3 Second Display Installation	10
3-4 Cash Drawer Installation.....	12
3-5 Wall Mount Kit.....	14
4 System Assembly & Disassembly.....	15
4-1 Replace the HDD.....	15
4-2 Replace the Power Adapter	16
4-3 Remove the System Stand	16
5 Specification	17
6 Jumper Settings	19
6-1 C56 Motherboard Layout.....	19
6-2 Connectors & Functions	20
6-3 Jumper Settings	21
7 Appendix: Driver Installation	25

1 Item Checklist

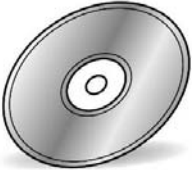
1-1 Standard Items

	
a. System	b. Power adapter (65W)
	
c. Power cable	d. COM-RJ45 cable (x2)
	
e. Driver CD	

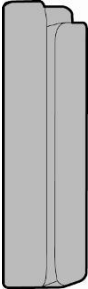
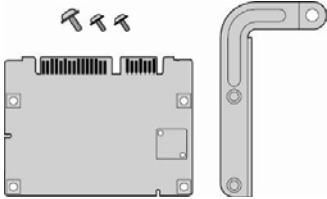
1-2 Optional Items

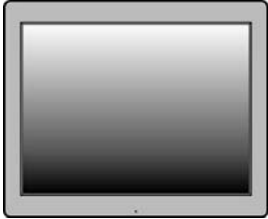
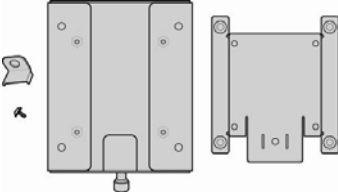
	
a. MSR module	b. SSD card module
	
c. VFD module	d. Second display
	
e. Wall mount kit	

2 System View

2-1 Front View



Number	Description
1	Touch screen
2	MSR module (Option)
3	Power button

2-2 Rear View



Number	Description
5	VFD cover (for VFD & Second display installation)
6	Stand/Wall mount kit installing place
7	Stand
8	Cable management outlet

2-3 Bottom View

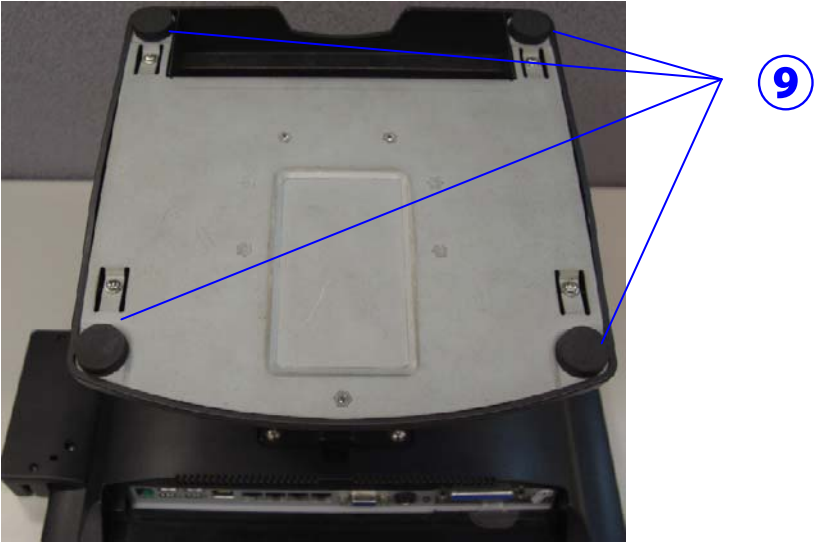

Number	Description
9	Stand pad

2-4 I/O View

Standard

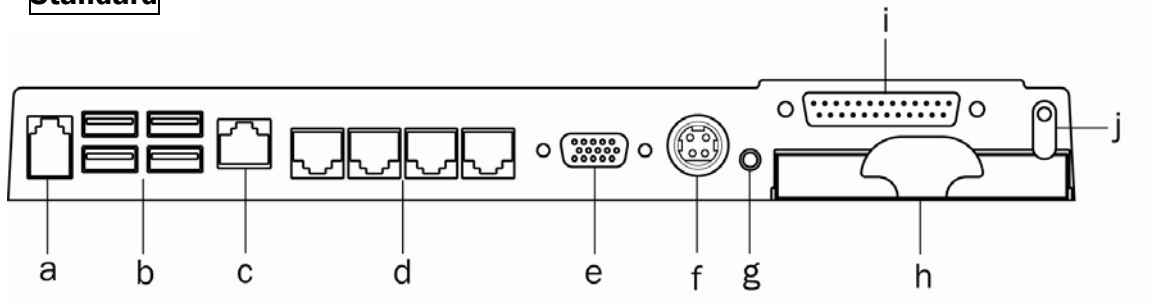

Optional

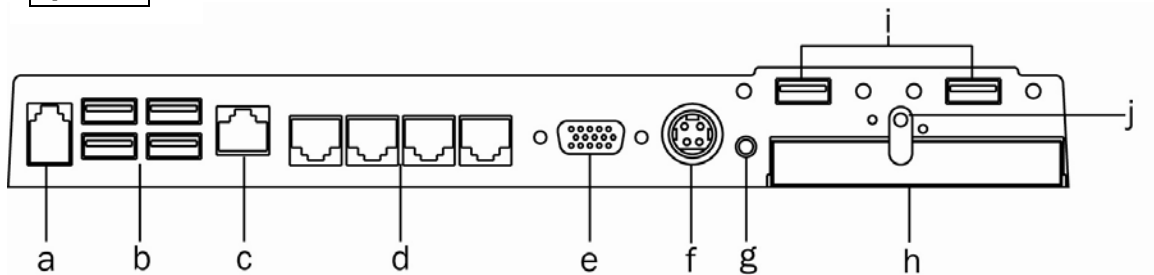

Number	Description
a	Cash drawer
b	USB x 4
c	LAN
d	COM1~4 (from right to left)
e	VGA
f	Power jack for system
g	Power button
h	HDD
i	Parallel (standard) / USB x 2 (optional)
j	HDD clip

Note: The maximum current that can be drawn from each COM port is 500 mA.

3 Peripherals Installation

3-1 MSR Installation



1. Open the dummy cover of the MSR.
2. Connect the MSR cable to the connector on the system.

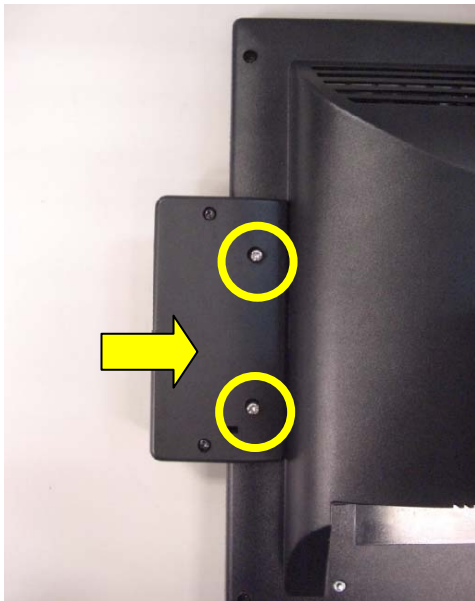

3. Insert the MSR module in place and fasten the screw (x2) on the back to secure the module.

3-2 VFD Installation

Accessories:

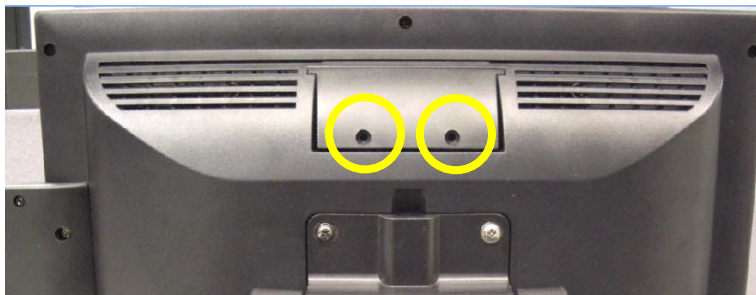
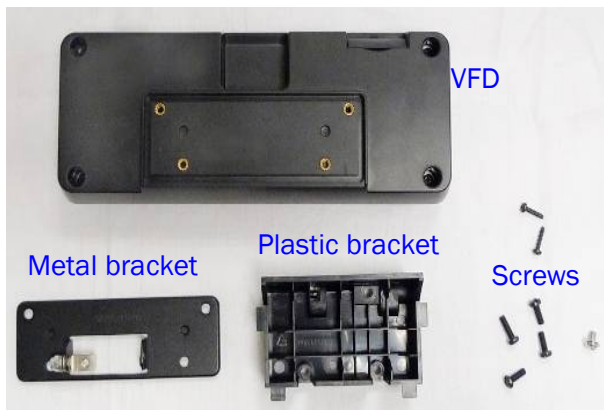

1. Remove the screws (x2) and slide the VFD cover outward.

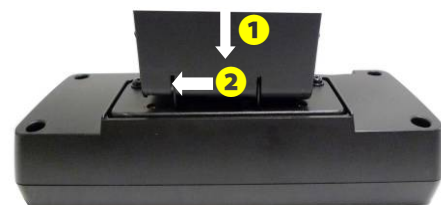
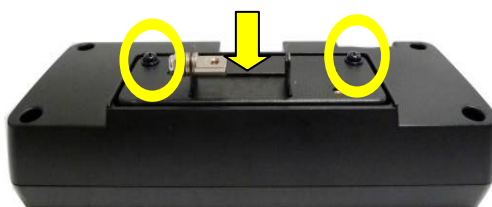

2. Positioning the VFD metal bracket onto the rear side of the VFD module and fasten the screws (x2).
3. Positioning the plastic bracket onto the metal bracket as shown in the picture.

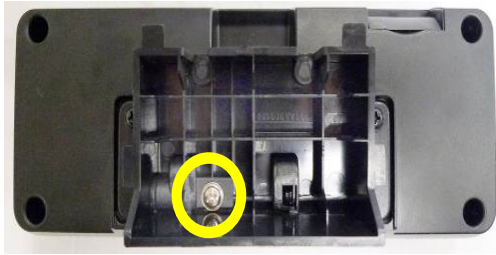

4. Fasten the screw (x1) to fix the plastic bracket to the metal bracket and VFD module.
5. Slide the VFD module with bracket into the VFD socket.
6. Fasten the screws (x2) to fix the VFD module.



7. Connect the VFD cable to the VFD module.



8. Connect the VFD cable to the COM4 port on the System.

3-3 Second Display Installation

To install the 8.4" second display, please open the VFD cover first (See chapter 3-2 step1).

Accessories:

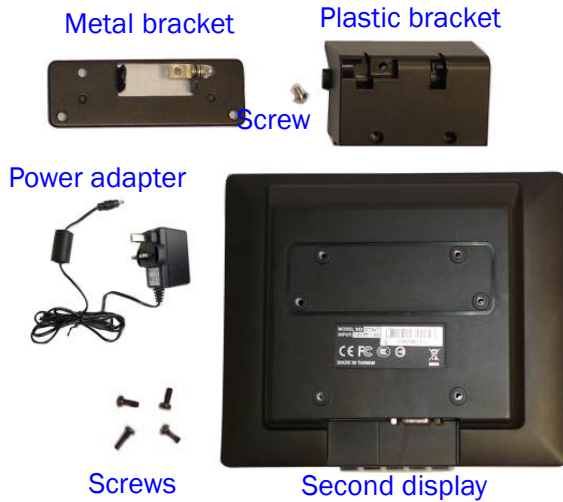

1. Place the system face down, make sure not to scratch the screen.
2. Place the metal bracket onto the rear side of the second display and fasten the screws (x4) to fix metal bracket with the system.
3. Align the plastic bracket onto the metal bracket, and push to the left side until it clicks in place.



4. Fasten the screw (x1) to fix the plastic bracket and second display module with metal bracket.
5. Slide the second display module into the slot.



6. Fasten the screws (x2) to fix the second display module with the system.
7. Connect the VGA cable to the second display module and the COM port on the system.



3-4 Cash Drawer Installation

You can install a cash drawer through the cash drawer port. Please verify the pin assignment before installation.

Cash Drawer Pin Assignment

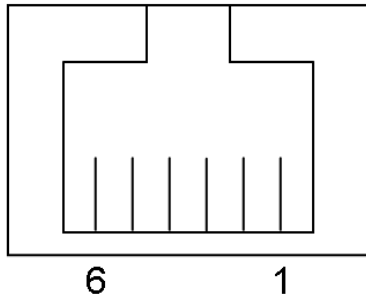

Pin	Signal
1	GND
2	DOUT bit0
3	DIN bit0
4	12V / 19V
5	DOUT bit1
6	GND

Cash Drawer Controller Register

The Cash Drawer Controller use one I/O addresses to control the Cash Drawer.

Register Location: 48Ch

Attribute: Read / Write

Size: 8bit

BIT	BIT7	BIT6	BIT5	BIT4	BIT3	BIT2	BIT1	BIT0
Attribute	Reserved	Read	Reserved	Reserved	Write	Write	Reserved	Reserved

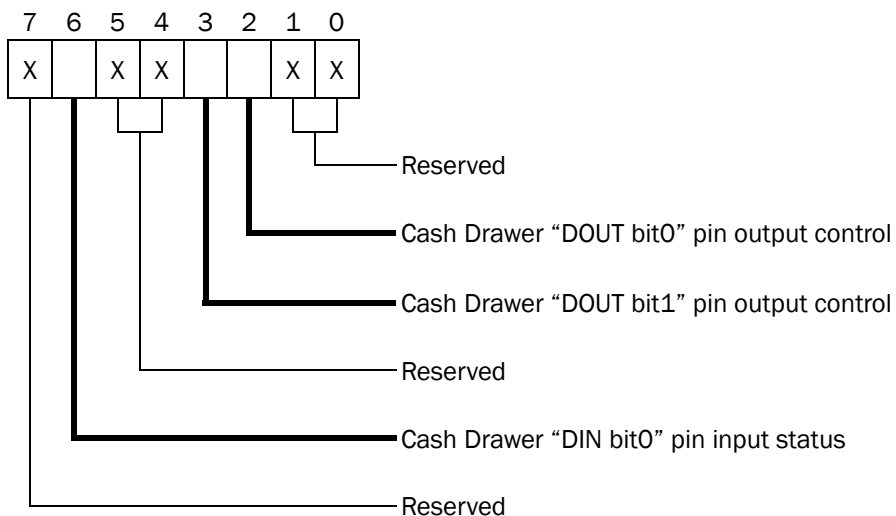

Bit 7: Reserved

Bit 6: Cash Drawer “DIN bit0” pin input status.

= 1: the Cash Drawer closed or no Cash Drawer

= 0: the Cash Drawer opened

Bit 5: Reserved

Bit 4: Reserved

Bit 3: Cash Drawer “DOUT bit1” pin output control.

= 1: Opening the Cash Drawer

= 0: Allow close the Cash Drawer

Bit 2: Cash Drawer “DOUT bit0” pin output control.

= 1: Opening the Cash Drawer

= 0: Allow close the Cash Drawer

Bit 1: Reserved

Bit 0: Reserved

Note: Please follow the Cash Drawer control signal design to control the Cash Drawer.

Cash Drawer Control Command Example

Use Debug.EXE program under DOS or Windows98

Command	Cash Drawer
O 48C 04	Opening
O 48C 00	Allow to close
<p>➤ Set the I/O address 48Ch bit2 =1 for opening Cash Drawer by “DOUT bit0” pin control.</p> <p>➤ Set the I/O address 48Ch bit2 = 0 for allow close Cash Drawer.</p>	

Command	Cash Drawer
I 48C	Check status
<p>➤ The I/O address 48Ch bit6 =1 mean the Cash Drawer is opened or not exist.</p> <p>➤ The I/O address 48Ch bit6 =0 mean the Cash Drawer is closed.</p>	

3-5 Wall Mount Kit

Before installing the Wall Mount Kit, please remove the stand first if needed. (See Chapter 4-3)

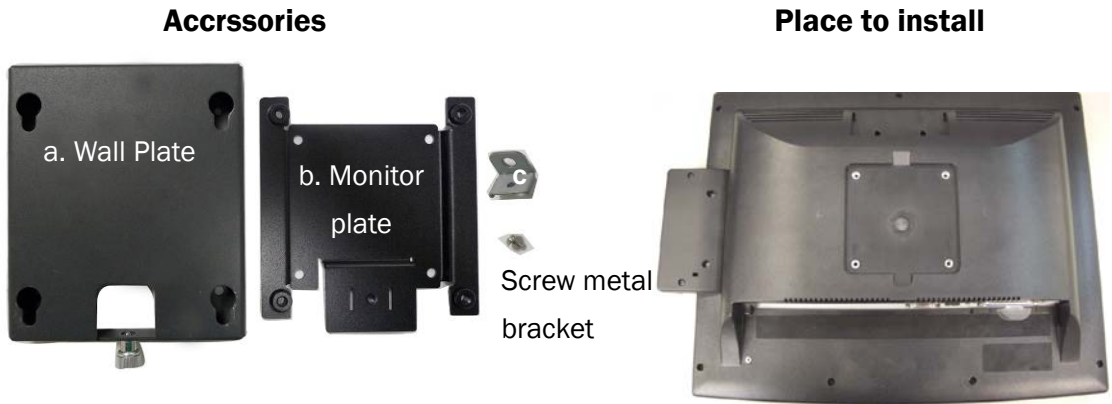

1. The wall mount Kit installing place is at the rear side of the system.

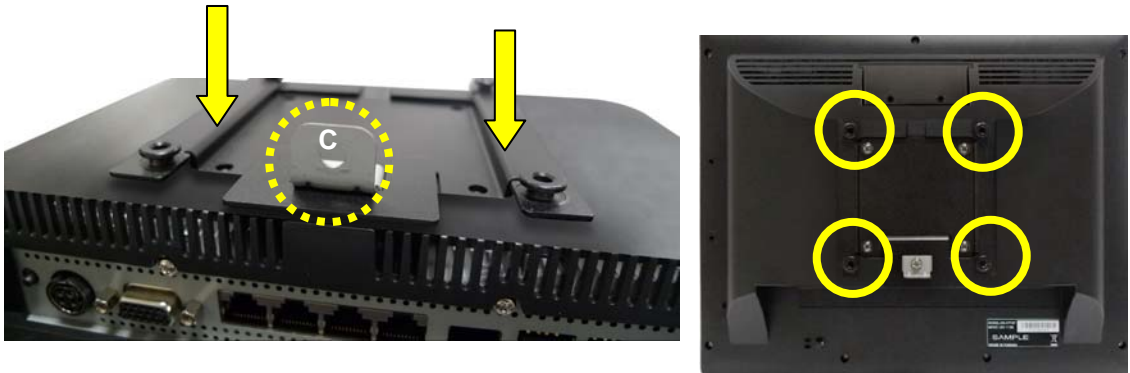

2. Place "b" onto the rear side of the LCD rear cover.
3. Place "c" onto the hole of the monitor plate and fasten the screw (x1).
4. Fasten the screws (x4) to fix the monitor plate.



5. Fix "a" on the wall.
6. Fasten the thumb screw (x1).
7. Align the large end of the teardrop mounting holes (x4) on the wall plate with the screws (x4) on the systems rear cover. Slide the wall plate until the screws are even with the narrow end.

4 System Assembly & Disassembly

4-1 Replace the HDD



1. Place the system face down. Make sure not to scratch the screen.

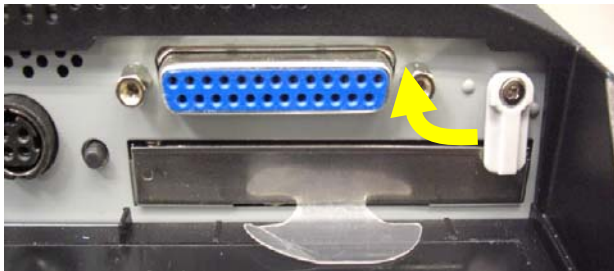

2. The HDD is secured by a clip, please push the clip aside as the picture shows.

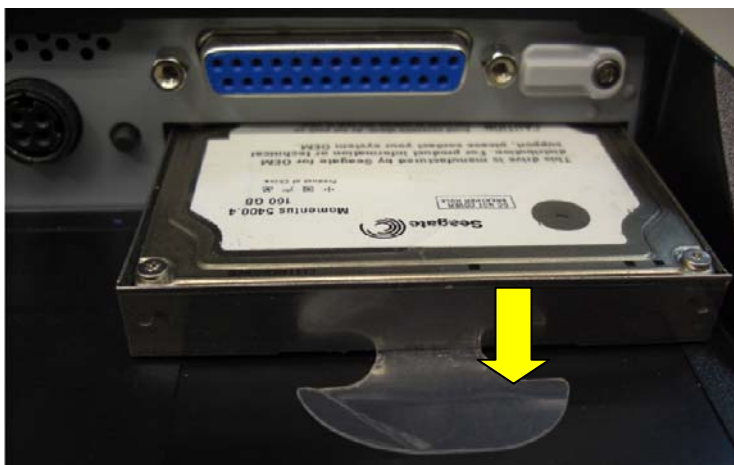

3. Pull the plastic tab (see picture) to remove the hard drive.

4-2 Replace the Power Adapter

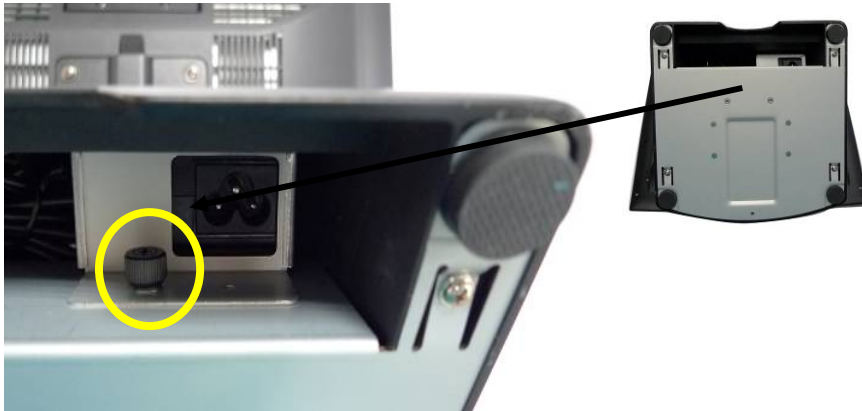

1. Unfasten the thumb screw (x1) to separate the retaining metal bracket from the stand and take out the power adapter.

4-3 Remove the System Stand



1. Remove the screws (x2) that secure the stand and the system.
2. Remove the screws (x4) that fasten the plastic VESA mounting plate and the LCD rear cover.

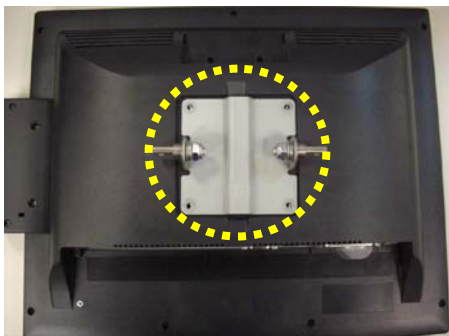

3. Remove the VESA metal bracket,.

5 Specification

Model Name	VT15
Motherboard	C56
CPU support	Intel Cedarview D2550 dual-core 1.86GHz, L2 1M
Chipset	CPU integrated graphic + NM10
System memory	1 x DDR3 SO-DIMM up to 4GB, 1066MHz
Graphic memory	Intel GMA 3650 (Gfx frequency up to 640MHz), DX9
LCD Touch Panel	
LCD size	15" LED
Brightness	250nits
Maximal resolution	1024 x 768
Touch screen type	Resistive
Tilt angle	4° ~ 84°
Storage	
HDD	One 2.5" SATA HDD bay
Flash memory	SATA SSD flash card (option)
Expansion	
PCI-E socket	1
External I/O Ports	
Parallel	1 (one parallel port is included in standard packing; optional packing includes two additional USB port instead of parallel port)
USB (V2.0)	4 or 6 (printer port is replaced with two additional USB)
Serial / COM	4 x RJ-45 COM connectors (COM1 & COM2 standard RS-232; COM3 & COM4 pin10 with 5V /12V power by BIOS)
LAN (10 /100 / 1000)	1 x RJ45
DC jack	1
2nd VGA	1 (DB-15 Female, power by BIOS configuration)
Cash drawer	1 (12V/24V cash drawer power by BIOS configuration)
Audio	
Speaker	2 x 2W speakers (Option)
Power	
Power adapter	65W, 19V/3.42A

Model Name	VT15
Motherboard	C56
Control / Indicator	
Power button	1
Indicator LED	1
Peripherals	
MSR module	MSR (USB)
Customer display	2 x 20 VFD customer display (COM)
Second display	8.4" 2nd display without touch
Environment	
EMC & Safety	FCC/CE Class A, LVD
Operating temperature	0°C ~ 35 °C (32 °F ~ 95 °F)
Storage temperature	-20 °C ~ 60 °C (-4 °F ~ 140 °F)
Humidity	20% ~ 85% RH non condensing
Dimension	LCD 4 degree : 365.2 x 296.2 x 282.2 mm
(W x D x H)	LCD 84 degree : 365.2 x 217.8 x 343.1 mm
Weight (N.W./G.W.)	5.8kgs / 6.8kgs
Mounting	100mm x100mm VESA standard holes
OS support	Windows® XP Professional, Windows Embedded, POSReady 2009, Windows XP Embedded, Windows XP Professional for Embedded, WinCE, Windows 7, Linux
* This specification is subject to change without prior notice.	

6 Jumper Settings

6-1 C56 Motherboard Layout

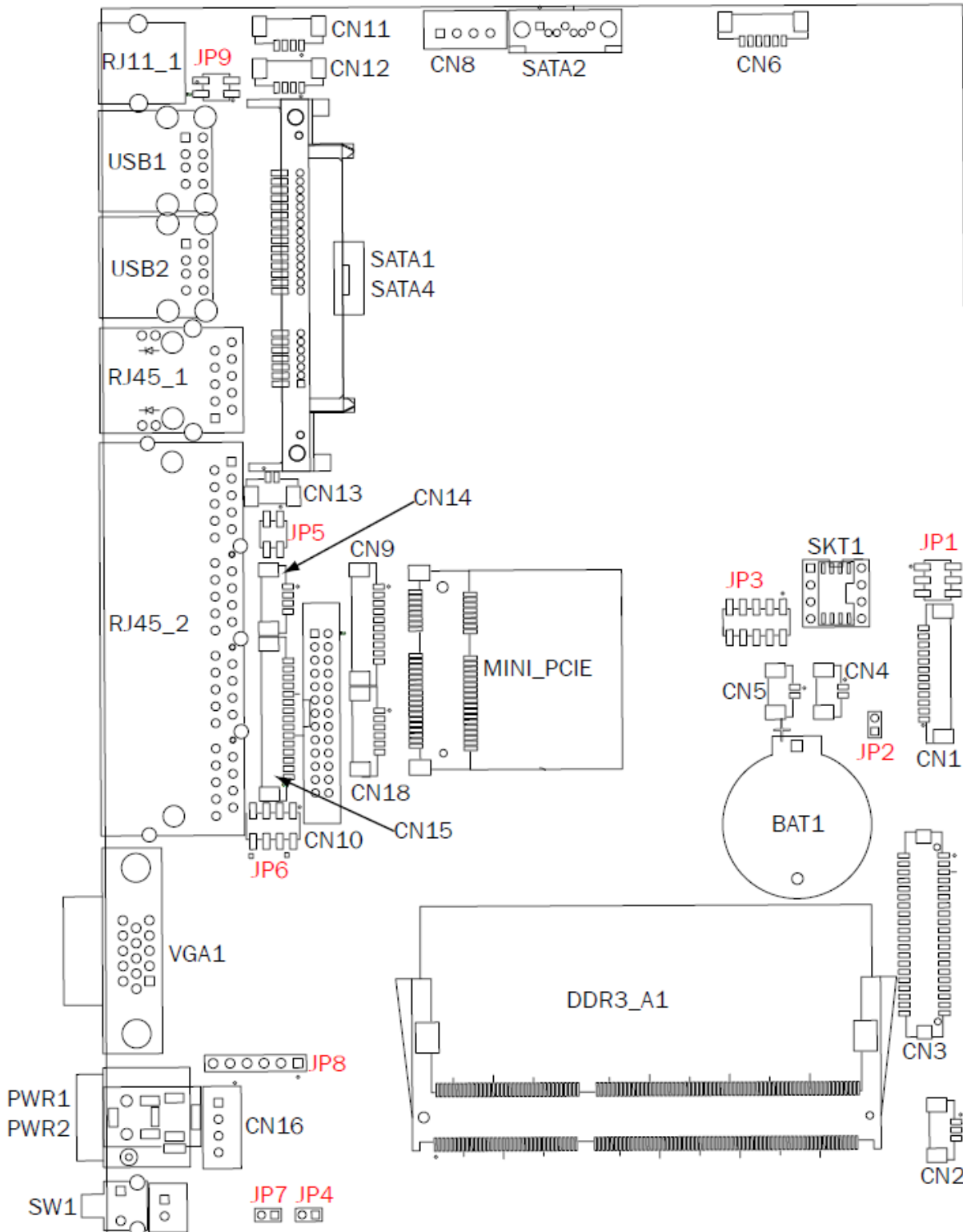

6-2 Connectors & Functions

Connectors	Functions
CN1	LVDS Inverter Connector
CN2	System FAN Connector
CN3	LVDS Connector
CN4	Power LED Connector
CN5	SATA LED Connector
CN6	Speaker & MIC Connector
CN8	SATA Power Connector
CN9	COM5(Touch) Connector
CN10	Printer Port Connector
CN11/12	USB Port(Internal)
CN13	LAN LED Connector
CN14	PS2 Keyboard Connector
CN15	Card Reader Connector(COM6)
CN16	+19V DC IN Connector
CN17	Power button(Internal)
CN18	Front I/O Connector(USB/power LED/ Power button)
PWR2/3	+19V DC JACK
RJ11_1	Cash Drawer Connector
RJ45_1	LAN Connector
RJ45_2	COM1/ COM2/ COM3/ COM4
DDR2_A1	DDR3 SO-DIMM
SATA1/2/4	SATA Connector
SKT1	BIOS Connector
USB1	USB6 USB7
USB2	USB4 USB5
VGA1	VGA Connector
SW1	Power button
JP1	Inverter Select
JP2	CMOS Operation Mode
JP3	LCD ID Setting
JP4	H/W Reset
JP5	COM2 Power Setting
JP6	COM3/COM4 Power Setting
JP7	Auto Button Setting
JP8	Touch Connector
JP9	CASH DRAWER Power Setting

6-3 Jumper Settings

Cash Drawer Power Setting

Function	JP9 (1-2) (3-4)						
▲ +19V	<table style="border-collapse: collapse; margin: auto;"> <tr> <td style="padding: 0 5px;">1</td> <td style="border: 1px solid black; padding: 2px 5px;">3</td> <td style="padding: 0 5px;"></td> </tr> <tr> <td style="padding: 0 5px;">2</td> <td style="border: 1px solid black; padding: 2px 5px;">4</td> <td style="padding: 0 5px;"></td> </tr> </table>	1	3		2	4	
1	3						
2	4						
+12V	<table style="border-collapse: collapse; margin: auto;"> <tr> <td style="padding: 0 5px;"></td> <td style="border: 1px solid black; padding: 2px 5px;">1</td> <td style="padding: 0 5px;">3</td> </tr> <tr> <td style="padding: 0 5px;"></td> <td style="border: 1px solid black; padding: 2px 5px;">2</td> <td style="padding: 0 5px;">4</td> </tr> </table>		1	3		2	4
	1	3					
	2	4					

Inverter Selection

Function	JP1 (1-2) (3-4) (5-6)						
▲ LED	<table style="border-collapse: collapse; margin: auto;"> <tr> <td style="padding: 0 5px;">1</td> <td style="border: 1px solid black; padding: 2px 5px;">3</td> <td style="padding: 0 5px;">5</td> </tr> <tr> <td style="padding: 0 5px;">2</td> <td style="border: 1px solid black; padding: 2px 5px;">4</td> <td style="padding: 0 5px;">6</td> </tr> </table>	1	3	5	2	4	6
1	3	5					
2	4	6					
CCFL	<table style="border-collapse: collapse; margin: auto;"> <tr> <td style="padding: 0 5px;">1</td> <td style="padding: 0 5px;">3</td> <td style="border: 1px solid black; padding: 2px 5px;">5</td> </tr> <tr> <td style="padding: 0 5px;">2</td> <td style="padding: 0 5px;">4</td> <td style="border: 1px solid black; padding: 2px 5px;">6</td> </tr> </table>	1	3	5	2	4	6
1	3	5					
2	4	6					

COM2 Power Setting

Function	JP5 (1-2) (3-4)				
▲ No Power	<table style="border-collapse: collapse; margin: auto;"> <tr> <td style="padding: 0 5px;">1</td> <td style="padding: 0 5px;">3</td> </tr> <tr> <td style="padding: 0 5px;">2</td> <td style="padding: 0 5px;">4</td> </tr> </table>	1	3	2	4
1	3				
2	4				
COM2 +5V	<table style="border-collapse: collapse; margin: auto;"> <tr> <td style="border: 1px solid black; padding: 2px 5px;">1</td> <td style="padding: 0 5px;">3</td> </tr> <tr> <td style="border: 1px solid black; padding: 2px 5px;">2</td> <td style="padding: 0 5px;">4</td> </tr> </table>	1	3	2	4
1	3				
2	4				
COM2 +12V	<table style="border-collapse: collapse; margin: auto;"> <tr> <td style="padding: 0 5px;">1</td> <td style="border: 1px solid black; padding: 2px 5px;">3</td> </tr> <tr> <td style="padding: 0 5px;">2</td> <td style="border: 1px solid black; padding: 2px 5px;">4</td> </tr> </table>	1	3	2	4
1	3				
2	4				

▲ = Manufacturer Default Setting



OPEN



SHORT

COM 3 & COM4 Power Setting

Function	JP6 (1-2) (3-4) (5-6) (7-8)								
▲ COM3 +5V	<table border="1"> <tr><td>1</td><td>3</td><td>5</td><td>7</td></tr> <tr><td>2</td><td>4</td><td>6</td><td>8</td></tr> </table>	1	3	5	7	2	4	6	8
1	3	5	7						
2	4	6	8						
COM3 +12V	<table border="1"> <tr><td>1</td><td>3</td><td>5</td><td>7</td></tr> <tr><td>2</td><td>4</td><td>6</td><td>8</td></tr> </table>	1	3	5	7	2	4	6	8
1	3	5	7						
2	4	6	8						
COM4+ 5V	<table border="1"> <tr><td>1</td><td>3</td><td>5</td><td>7</td></tr> <tr><td>2</td><td>4</td><td>6</td><td>8</td></tr> </table>	1	3	5	7	2	4	6	8
1	3	5	7						
2	4	6	8						
▲ COM4 +12V	<table border="1"> <tr><td>1</td><td>3</td><td>5</td><td>7</td></tr> <tr><td>2</td><td>4</td><td>6</td><td>8</td></tr> </table>	1	3	5	7	2	4	6	8
1	3	5	7						
2	4	6	8						

COM2/COM3/COM4 Power Setting

COM2, COM3 and COM4 can be set to provide power to your serial device.

The voltage can be set to +5V or +12V by setting jumper JP5 and JP6 on the

motherboard. When enabled, the power is available on pin 10 of the RJ45 serial

connector. If you use the serial RJ45 to DB9 adapter cable, the power is on pin 9 of

the DB9 connector. By default, the power option is **disabled** in the BIOS.

1. Power on the system, and press the key when the system is booting up to enter the BIOS Setup utility.
2. Select the Advanced tab.
3. Select **VGA/COM Power and LCD Brightness Configuration** Ports and press <Enter> to go to display the available options.
4. To enable the power, select COM2 , COM3 or COM4 Power setting and press <Enter>. Select Power and press <Enter>. Save the change by pressing F10.

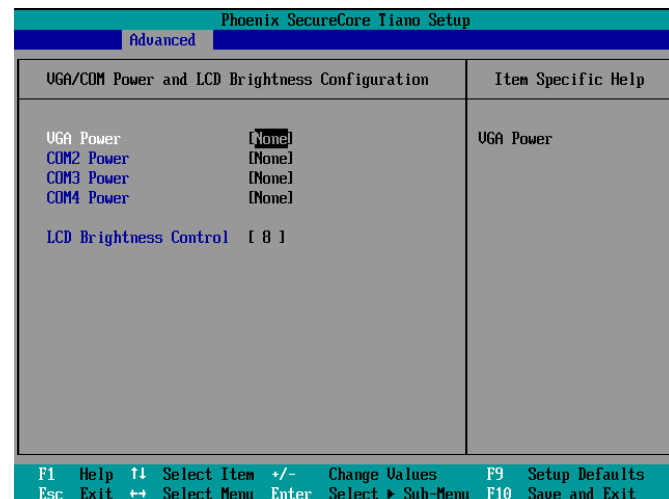
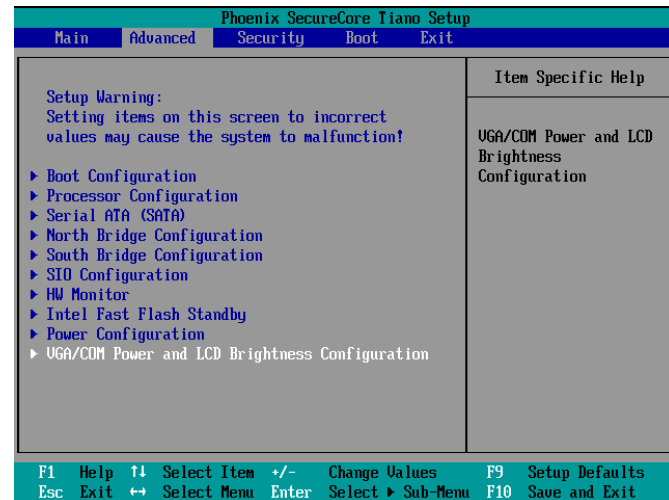

LCD ID Setting

Panel Number	Resolution	LVDS		Output Interface	JP3 (1-2) (3-4) (5-6) (7-8) (9-10)										
		Bits	Channel												
1	800 x 600	18	Single	LVDS Panel	<table style="border-collapse: collapse; margin: auto;"> <tr><td>1</td><td>3</td><td>5</td><td>7</td><td>9</td></tr> <tr><td>2</td><td>4</td><td>6</td><td>8</td><td>10</td></tr> </table>	1	3	5	7	9	2	4	6	8	10
1	3	5	7	9											
2	4	6	8	10											
2	800 x 600	18	Single	LVDS Panel	<table style="border-collapse: collapse; margin: auto;"> <tr><td>1</td><td>3</td><td>5</td><td>7</td><td>9</td></tr> <tr><td>2</td><td>4</td><td>6</td><td>8</td><td>10</td></tr> </table>	1	3	5	7	9	2	4	6	8	10
1	3	5	7	9											
2	4	6	8	10											
3	800 x 600	24	Single	LVDS Panel	<table style="border-collapse: collapse; margin: auto;"> <tr><td>1</td><td>3</td><td>5</td><td>7</td><td>9</td></tr> <tr><td>2</td><td>4</td><td>6</td><td>8</td><td>10</td></tr> </table>	1	3	5	7	9	2	4	6	8	10
1	3	5	7	9											
2	4	6	8	10											
4	1024 x 600	18	Single	LVDS Panel	<table style="border-collapse: collapse; margin: auto;"> <tr><td>1</td><td>3</td><td>5</td><td>7</td><td>9</td></tr> <tr><td>2</td><td>4</td><td>6</td><td>8</td><td>10</td></tr> </table>	1	3	5	7	9	2	4	6	8	10
1	3	5	7	9											
2	4	6	8	10											
5	1024 x 768	18	Single	LVDS Panel	<table style="border-collapse: collapse; margin: auto;"> <tr><td>1</td><td>3</td><td>5</td><td>7</td><td>9</td></tr> <tr><td>2</td><td>4</td><td>6</td><td>8</td><td>10</td></tr> </table>	1	3	5	7	9	2	4	6	8	10
1	3	5	7	9											
2	4	6	8	10											
6	800 x 600	24	Single	LVDS Panel	<table style="border-collapse: collapse; margin: auto;"> <tr><td>1</td><td>3</td><td>5</td><td>7</td><td>9</td></tr> <tr><td>2</td><td>4</td><td>6</td><td>8</td><td>10</td></tr> </table>	1	3	5	7	9	2	4	6	8	10
1	3	5	7	9											
2	4	6	8	10											
7	1024 x 768	24	Single	LVDS Panel	<table style="border-collapse: collapse; margin: auto;"> <tr><td>1</td><td>3</td><td>5</td><td>7</td><td>9</td></tr> <tr><td>2</td><td>4</td><td>6</td><td>8</td><td>10</td></tr> </table>	1	3	5	7	9	2	4	6	8	10
1	3	5	7	9											
2	4	6	8	10											
10	1366 x 768	18	Single	LVDS Panel	<table style="border-collapse: collapse; margin: auto;"> <tr><td>1</td><td>3</td><td>5</td><td>7</td><td>9</td></tr> <tr><td>2</td><td>4</td><td>6</td><td>8</td><td>10</td></tr> </table>	1	3	5	7	9	2	4	6	8	10
1	3	5	7	9											
2	4	6	8	10											
11	1366 x 768	24	Single	LVDS Panel	<table style="border-collapse: collapse; margin: auto;"> <tr><td>1</td><td>3</td><td>5</td><td>7</td><td>9</td></tr> <tr><td>2</td><td>4</td><td>6</td><td>8</td><td>10</td></tr> </table>	1	3	5	7	9	2	4	6	8	10
1	3	5	7	9											
2	4	6	8	10											
				CRT	<table style="border-collapse: collapse; margin: auto;"> <tr><td>1</td><td>3</td><td>5</td><td>7</td><td>9</td></tr> <tr><td>2</td><td>4</td><td>6</td><td>8</td><td>10</td></tr> </table>	1	3	5	7	9	2	4	6	8	10
1	3	5	7	9											
2	4	6	8	10											

*Panel No.6 for 8.4" (HSD0841SN1-A01)HANNSTAR and 10.4" (A1048N03 V.1) AUO

2nd VGA Power Setting

1. Power on the system, and press the key when the system is booting up to enter the BIOS Setup utility.
2. Select the Advanced tab.
3. Select **VGA/COM Power and LCD Brightness Configuration** Ports and press <Enter> to go to display the available options.
4. To switch on the power, select "+12V" press <Enter>. Please Save the change by pressing F10.

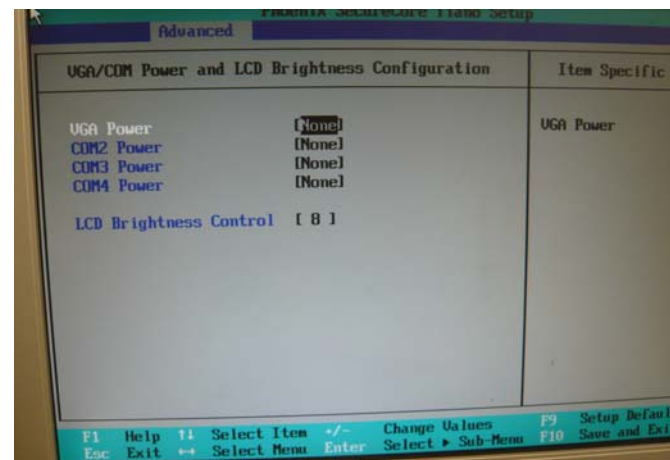
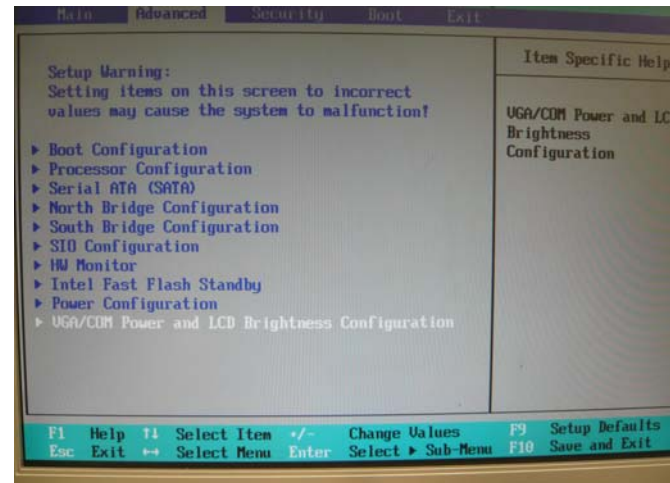

7 Appendix: Driver Installation

The shipping package includes a Driver CD. You can find every individual driver and utility that enables you to install the drivers in the Driver CD.

Please insert the Driver CD into the drive and double click on the “index.htm” to pick the models. You can refer to the drivers installation guide for each driver in the “Driver/Manual List”.